

# HURRICANE SIDE WIND

## ASSEMBLY INSTRUCTIONS

Parts list;

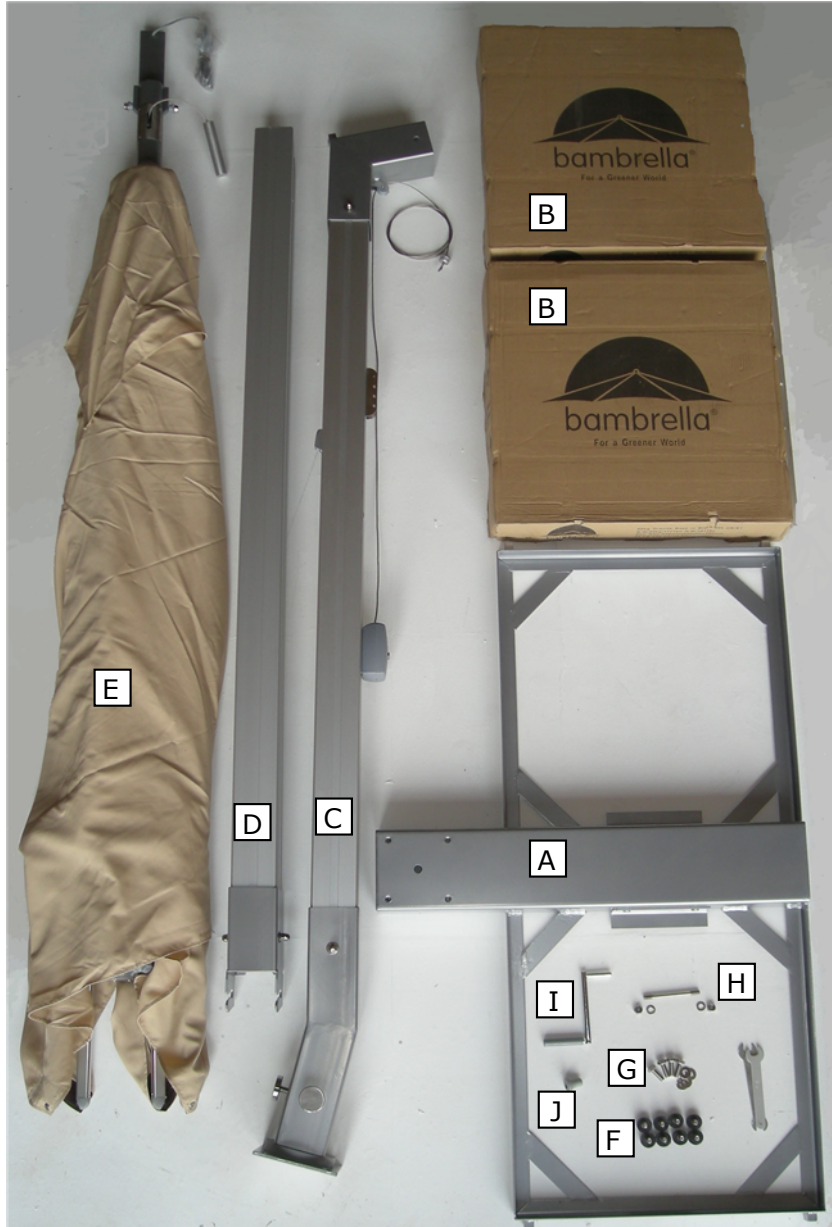

PART	DESCRIPTION	PART	DESCRIPTION
A	BASE FRAME	F	8 X FEET
B	BASE WEIGHTS	G	4 X BOLTS AND WASHERS
C	POST A	H	1 X LONG BOLT, WASHERS AND LOCK-NUTS
D	POST B	I	WINCH HANDLE
E	UMBRELLA	J	PULL HANDLE

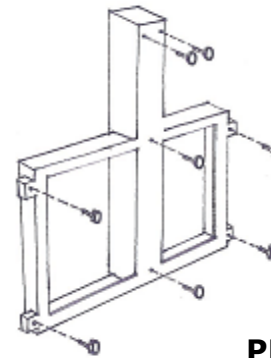

Screw the plastic feet (**F**) to the underside of the base frame (**A**).

**PLACE THE BASE FRAME IN THE DESIRED (FINAL) POSITION NOW, AS IT WILL BE DIFFICULT TO MOVE ONCE THE BASE WEIGHTS ARE IN PLACE.**

Adjust the feet to allow for uneven ground.

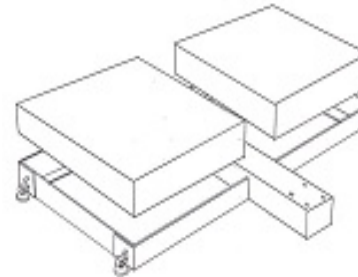

The next step will require 2 people, because of the weight of the bases.

Place the base weights (**B**) in the base frame (**A**).

Bolt post **C** to the base frame using the 4 bolts and washers (**G**). Tighten with the spanner(s) provided.



Using a suitable ladder, put the angled part of post **D** into the bracket at the top of post **C**. The cutouts face up. Secure with the long bolt, washers and nuts (**H**) using the spanners provided.

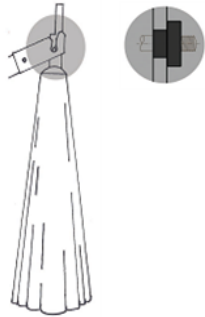
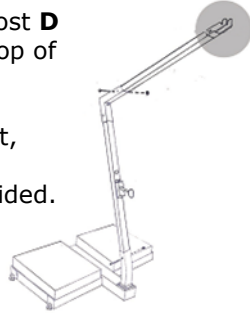

Next, remove the nuts and washers from the bolt at the top of the umbrella (**E**), and hang the umbrella in the bracket. (The wire faces toward the post) Then put the grey plastic washers onto the bolt making sure they sit inside the round cutout parts of the bracket. Secure with the self locking nuts, using the spanners provided.

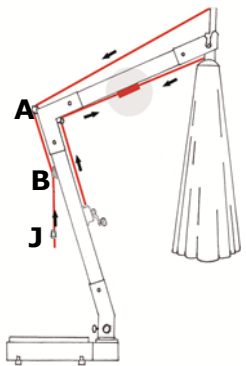

### Top rope

Thread the top rope (from the top of the tube), over the pulley at **A**. See diagram left.

Run the rope through the looped part of the cleat at **B**.

Thread the rope through the hole in the grey finger pull (**J**).

Tie a simple knot on the end of the rope and pull the handle down. The knot should sit in the end recess.

### Winch wire

The wire loops are joined by a locking carabiner (diagram left), **which must be fastened securely using the locking nut, or damage/injury may occur.**

Secure the end-cap on the end of the tube.

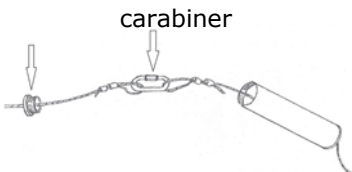

### OPENING AND CLOSING:

1. When opening the umbrella, turn the handle on the winch, clockwise, until the slack is taken out of the wire.
2. Pull all the arms of the umbrella outwards slightly, to make sure they are free to move. Continue turning the handle until the umbrella is fully up.

If the umbrella doesn't open. **Do not try to force the winch** Slacken the wire slightly and repeat step **2.** above left.

Please remove the winch handle when not in use, for safety, and also this part is not weather resistant.

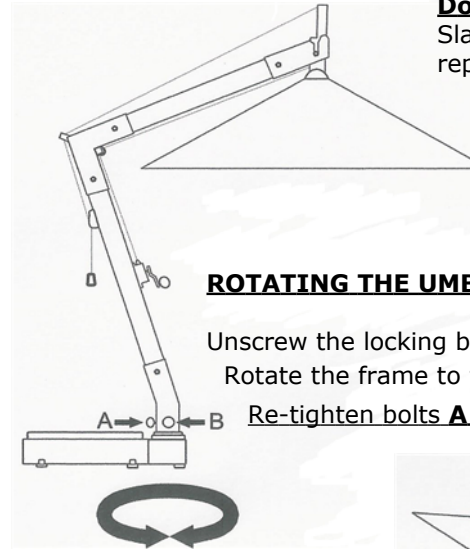

### ROTATING THE UMBRELLA FRAME

Unscrew the locking bolts **A** and **B** until loose. Rotate the frame to the desired position.

Re-tighten bolts **A** and **B**.

### LOCKING AND TILTING THE UMBRELLA

The locking arm **C** (right), can be used to secure the canopy in the open position, by using the bracket and pin on the post.

### TILTING

First undo the locking arm **C** (if fixed).

Tilt the umbrella by pulling down on the rope-pull **J**, and at the same time, pushing downwards on the arm nearest the post.

Lock the rope in the cleat to secure in position.

